

ESCALIERS SPIRALES EN ALUMINIUM
ALUMINIUM SPIRAL STAIRCASES

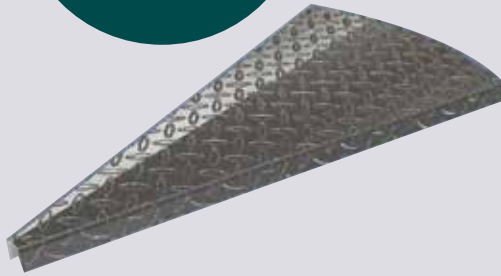

Marches en plaques antidérapantes en aluminium
Aluminium checker plate steps



CARACTÉRISTIQUES

Escaliers en spirale en aluminium

Nos escaliers sont fabriqués en aluminium à partir d'alliages de très haute résistance qui sont soudés ensemble.

Marches en plaques antidérapantes

Les marches sont en plaques d'aluminium antidérapantes (checker-plate) et le reste de la structure est fabriqué avec des profilés d'aluminium.

Largeur des marches

30" ou 36".

Finition

Peinture cuite.

Rampes

En barreaux 1" x 1"
ou style tradition barreaux
3/8" x 3/8"

Fabriqués sur mesures seulement. Des paliers et escaliers droits sont également disponibles. Consultez le code de bâtiment de votre localité pour la légalité de ce genre d'escalier.

FEATURES

Aluminium spiral staircases

Our spirals are made entirely of high strength aluminium alloy components that are welded together.

Steps in checker-plate

The steps are made of high strength aluminium checker-plate while the rest of the structure is made of aluminium extrusion.

Width of steps

30" or 36".

Finish

Baked paint.

Railing

With balusters 1" x 1" or tradition style. 3/8" x 3/8"

Custom made only. Landings and straight staircases also available. Consult your local building code for the legality of these types of stairs

SPÉCIFICATIONS
SPECIFICATIONS

Tourelle à barrotins
Baluster Turret
1" x 1"

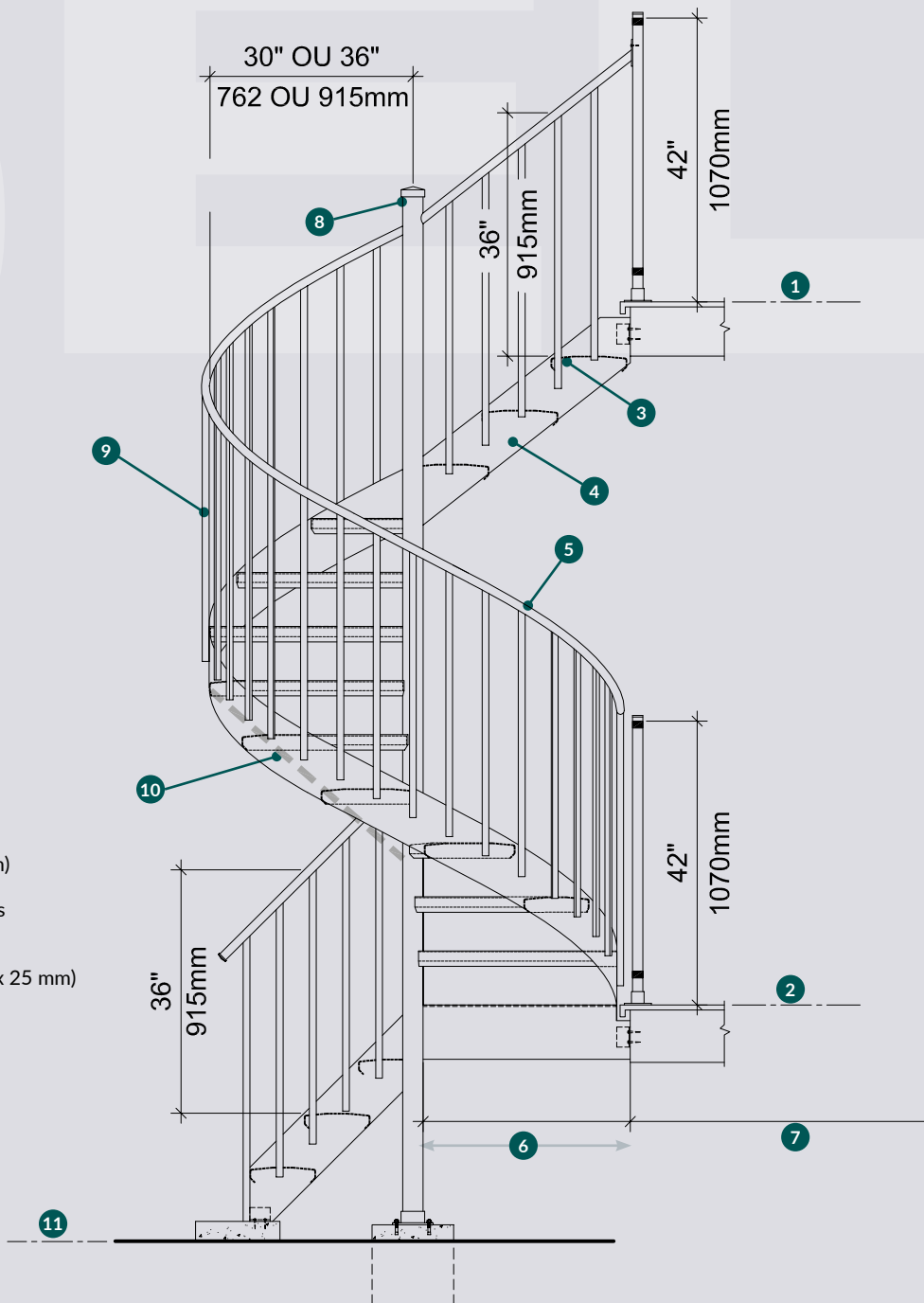

- 1 Balcon étage
- 2 Balcon R.D.C.
- 3 Marches pl. striée
- 4 Limons pl.8" (200 mm)
- 5 Main-courante tuyau rond 1.25" (32 mm)
- 6 Palier droit
- 7 Limon pl.8" (200 mm) et pl. striée dessus
- 8 Poteau rond 3" (76 mm)
- 9 Barrotins tube 1"x 1" (25 mm x 25 mm)
- 10 Renforts (3 requis) Tube 1"x 1" (25 mm x 25 mm)
- 11 Sol

- 1 First floor balcony
- 2 Ground floor balcony
- 3 Striated steps
- 4 8" stringers (200 mm)
- 5 Round tubular handrail 1.25" (32 mm)
- 6 Straight bearing
- 7 8" stringer (200 mm) and top striated
- 8 Round post 3" (76 mm)
- 9 Tube balusters 1"x 1" (25 mm x 25 mm)
- 10 Reinforcements (3 required)
Tube 1"x 1" (25 mm x 25 mm)
- 11 Ground

COULEURS STANDARD
STANDARD COLOURS

- Blanc | White
- Noyer | Hickory
- Brun commercial | Commercial Brown
- Gris charbon | Charcoal Grey
- Noir | Black

SPÉCIFICATIONS
SPECIFICATIONS



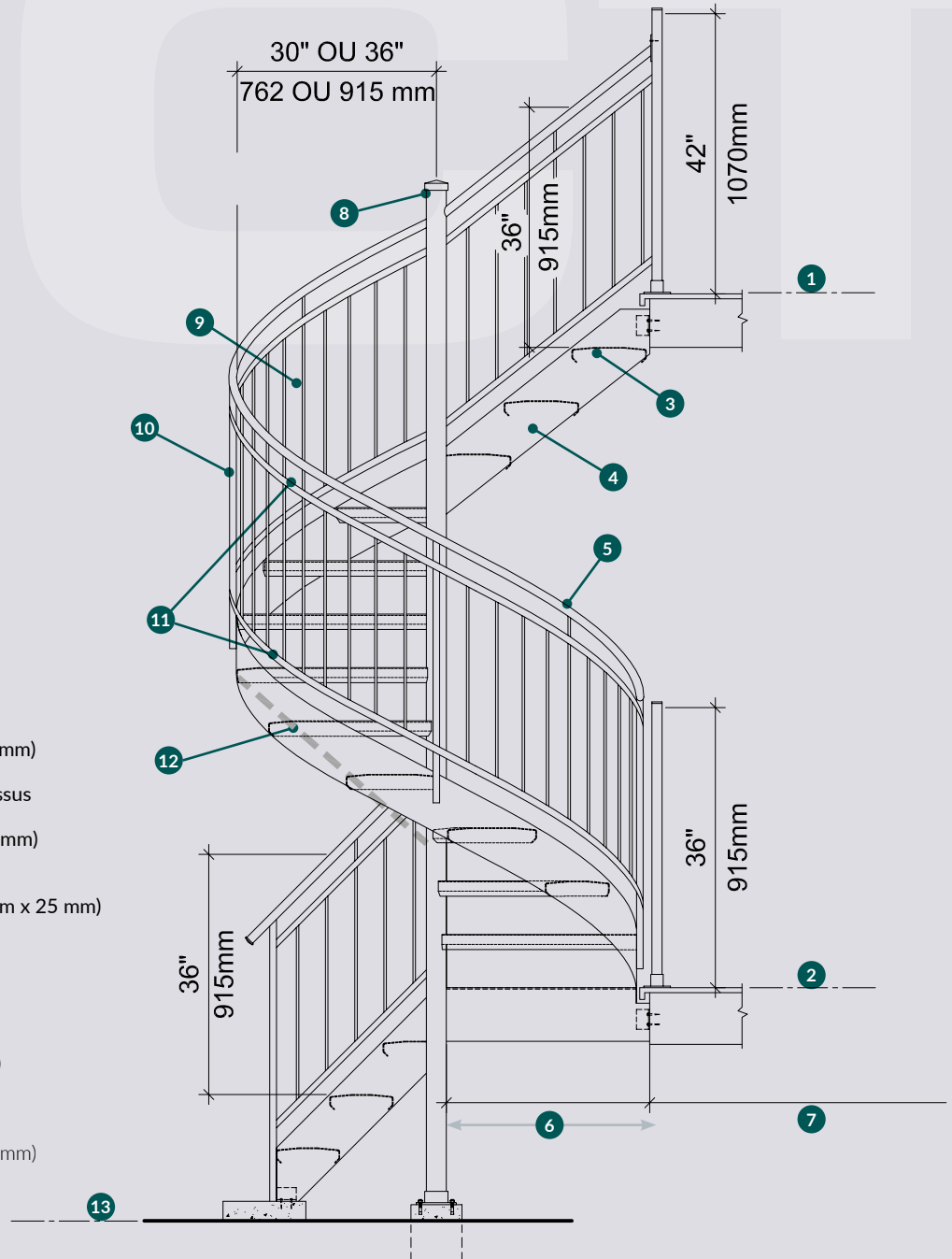

Tourelle Style Tradition
Tradition Style Turret
3/8" x 3/8"



- 1 Balcon étage
- 2 Balcon R.D.C.
- 3 Marches pl. striée
- 4 Limons pl.8" (200 mm)
- 5 Main-courante tuyau rond 1.25" (32 mm)
- 6 Palier droit
- 7 Limon pl.8" (200 mm) et pl. striée dessus
- 8 Poteau rond 3" (76 mm)
- 9 Barrotins tube 3/8"x 3/8" (9,5 mm x 9,5 mm)
- 10 Tube 1"x 1" (25 mm x 25 mm)
- 11 Plats 1 1/2"x 3/16" (38 mm x 5 mm)
- 12 Renforts (3 requis) Tube 1"x 1" (25 mm x 25 mm)
- 13 Sol

- 1 First floor balcony
- 2 Ground floor balcony
- 3 Striated steps
- 4 8" stringers (200 mm)
- 5 Round tubular handrail 1.25" (32 mm)
- 6 Straight bearing
- 7 8" stringer (200 mm) and top striated
- 8 Round post 3" (76 mm)
- 9 Tube balusters 3/8"x 3/8" (9.5 mm x 9.5 mm)
- 10 Tube 1"x 1" (25 mm x 25 mm)
- 11 Flats 1 1/2"x 3/16" (38 mm x 5 mm)
- 12 Reinforcements (3 required) Tube 1"x 1" (25mm x 25 mm)
- 13 Ground

COULEURS STANDARD
STANDARD COLOURS

-  Blanc | White
-  Noyer | Hickory
-  Brun commercial | Commercial Brown
-  Gris charbon | Charcoal Grey
-  Noir | Black





ESCALIERS SOUDÉS PATRIMOINE WELDED HERITAGE STAIRS

Escaliers soudés
patrimoine
Welded heritage
stairs



CARACTÉRISTIQUES

Escaliers soudés patrimoine

Ces escaliers en aluminium sont faits pour rencontrer les exigences des villes et arrondissements qui ont des règlements de patrimoine en place demandent que les escaliers aient la même apparence que le fer forgé d'origine. Les limons et garde-corps sont entièrement en aluminium soudés et sont recouverts avec une peinture en poudre. Ces escaliers sont installés avec des marches en fibre de verre qui ont habituellement 42" (1067 mm) de large.

Limons

Plaque aluminium 12" x 3/16"
(305 mm x 4,8 mm)

Rampes

Barreaux aluminium 3/8" x 3/8"
(9,5 mm x 9,5 mm)

Main courante 1 1/4" (32 mm)
diamètre ronde

FEATURES

Welded heritage stairs

These aluminium stairs are made to meet the requirements of those cities and boroughs that have heritage by-laws in place requiring stairs to have the same appearance as the original wrought iron. The stringers and railing are entirely welded out of aluminium and powder coated. These stairs are installed with fiberglass steps that are usually 42" (1067 mm) wide.

Stringers





Aluminium plate 12" x 3/16"
(305 mm x 4.8 mm)

Railing

Aluminium pickets 3/8" x 3/8"
(9.5 mm x 9.5 mm)

Aluminium hand rail 1 1/4"
(32 mm) diameter round

LIMONS ET RAMPES STRINGERS AND RAILINGS

-  Blanc | White
-  Noyer | Hickory
-  Brun commercial | Commercial Brown
-  Gris charbon | Charcoal Grey
-  Noir | Black



SPÉCIFICATIONS
SPECIFICATIONS

Escalier et garde-corps
patrimoine soudé
Welded Heritage Stairs
and Railings





RAMPE Soudés WELDED RAILING



Tradition
Tradition



Diamant
Diamond



Rotondo
Rotondo

CARACTÉRISTIQUES

Rampes soudés patrimoine

Ces rampes en aluminium sont faites pour rencontrer les exigences des villes et arrondissements qui ont des règlements de patrimoine semblable au fer forgé d'origine. Les garde-corps sont entièrement en aluminium soudés et sont recouverts avec une peinture en poudre.

Rampes

Barreaux aluminium $\frac{3}{8}$ " x $\frac{3}{8}$ "
(9,5 mm x 9,5 mm)

Main courante $1\frac{1}{4}$ " (32 mm)
diamètre ronde.

FEATURES

Welded heritage railing





These aluminium railings are made to meet the requirements of those cities and boroughs that have heritage by-laws in place requiring railings to have a similar appearance as the original wrought iron. The railing is entirely welded out of aluminium and powder coated.

Railing

Aluminium pickets $\frac{3}{8}$ " x $\frac{3}{8}$ "
(9.5 mm x 9.5 mm)

Aluminium hand rail $1\frac{1}{4}$ "
(32 mm) diameter round.

COULEURS STANDARD STANDARD COLOURS

-  Blanc | White
-  Noyer | Hickory
-  Brun commercial | Commercial Brown
-  Gris charbon | Charcoal Grey
-  Noir | Black



SPÉCIFICATIONS SPECIFICATIONS

Patrimoine Tradition
Heritage Tradition

Modèle standard

- Garde-corps de 36" (900 mm) et 42" (1070 mm) de haut
- Moins de 4" (100 mm) entre le dessous de la rail du bas et le dessus de la dalle

Regular Design

- Railing 36" (900 mm) and 42" (1070 mm) high
- Maximum of 4" (100 mm) between bottom rail and the slab

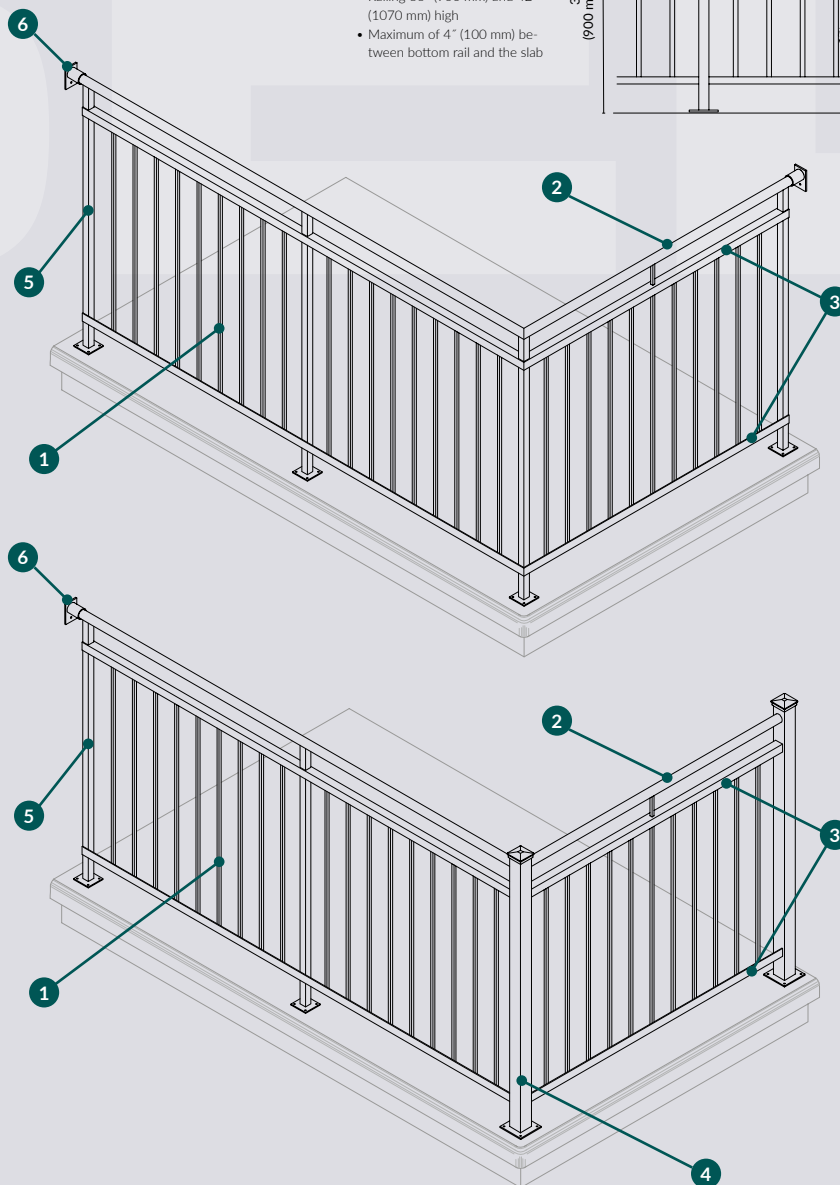
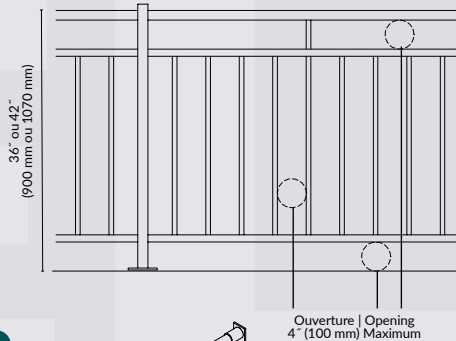

- 1 Barrotins carrés $\frac{3}{8}$ " x $\frac{3}{8}$ " (9,5 mm x 9,5 mm) en aluminium
- 2 Main-courante ronde 1 $\frac{1}{4}$ " Ø (32 mm Ø) en aluminium
- 3 Cornières 1 $\frac{1}{4}$ " x 1 $\frac{1}{4}$ " (32 mm x 32 mm) en aluminium
- 4 Poteau S-200 2" x 2" (51 mm x 51 mm) en aluminium
- 5 Poteau tubulaire 1" x 1" (25 mm x 25 mm) en aluminium
- 6 Attache murale

- 1 Aluminium square pickets $\frac{3}{8}$ " x $\frac{3}{8}$ " (9,5 mm x 9,5 mm)
- 2 Aluminium round handrail 1 $\frac{1}{4}$ " Ø (32 mm Ø)
- 3 Aluminium angles 1 $\frac{1}{4}$ " x 1 $\frac{1}{4}$ " (32 mm x 32 mm)
- 4 Aluminium S-200 post 2" x 2" (51 mm x 51 mm)
- 5 Aluminium tubular post 1" x 1" (25 mm x 25 mm)
- 6 Wall mount

COULEURS STANDARD STANDARD COLOURS

- Blanc | White
- Noyer | Hickory
- Brun commercial | Commercial Brown
- Gris charbon | Charcoal Grey
- Noir | Black

Ces garde-corps sont entièrement en aluminium soudés et sont recouverts d'une peinture en poudre.

These railings are entirely welded out of aluminium and powder coated.

Nos garde-corps sont faits pour rencontrer les exigences des villes et arrondissements qui ont des règlements de patrimoine semblable au fer forgé d'origine. | Our railings meet the requirements of those cities and boroughs that have heritage by-laws in place requiring railings to have a similar appearance as the original wrought iron.

Consultez les échantillons pour les couleurs exactes et les disponibilités. | Consult our samples for exact colors and availability.



SPÉCIFICATIONS SPECIFICATIONS

Patrimoine Diamant Heritage Diamond

Modèle standard

- Garde-corps de 36" (900 mm) et 42" (1070 mm) de haut
- Moins de 4" (100 mm) entre le dessous de la rail du bas et le dessus de la dalle

Regular Design

- Railing 36" (900 mm) and 42" (1070 mm) high
- Maximum of 4" (100 mm) between bottom rail and the slab

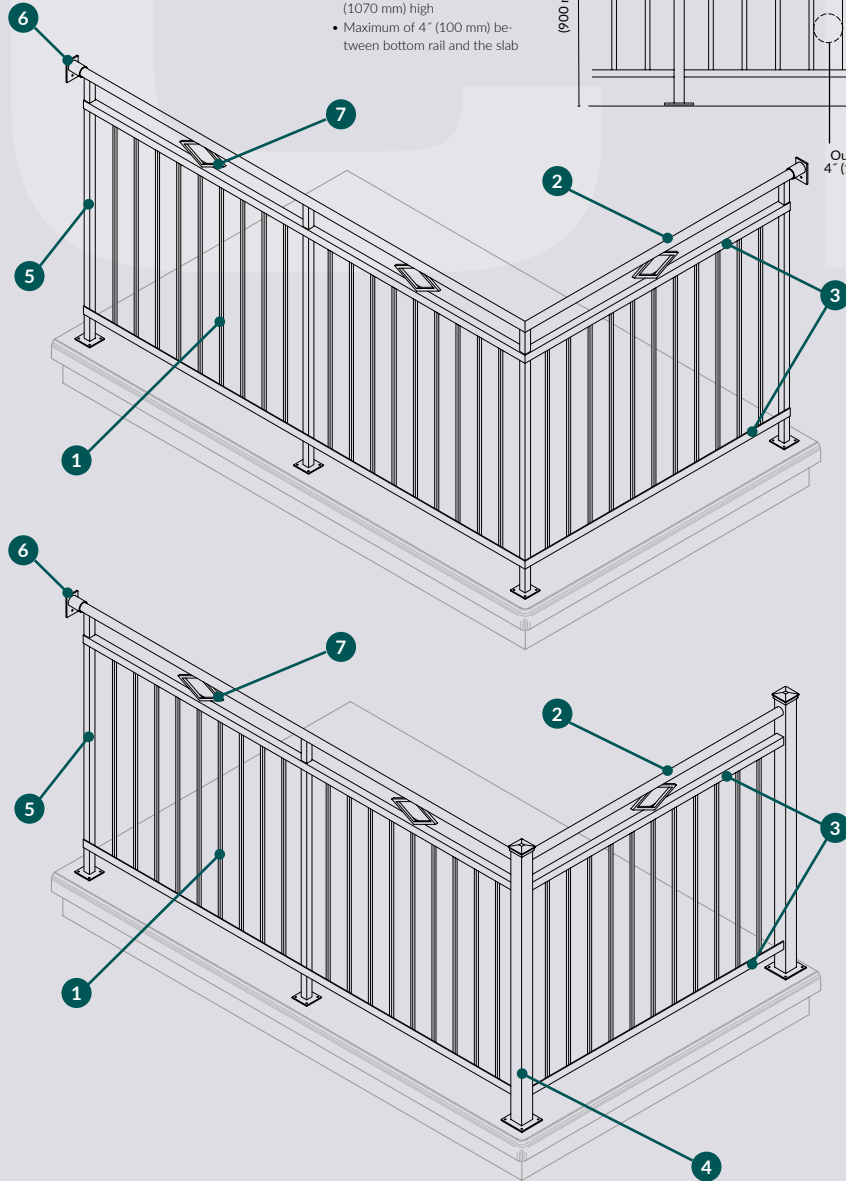
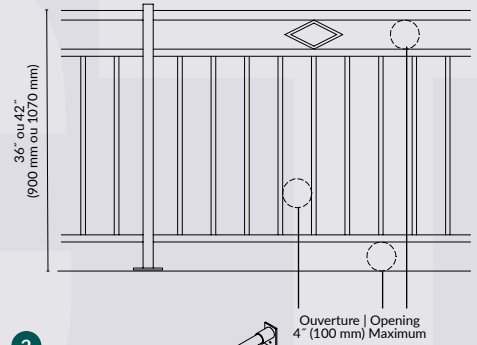

- 1 Barrotins carrés $\frac{3}{8}$ " x $\frac{3}{8}$ " (9,5 mm x 9,5 mm) en aluminium
- 2 Main-courante ronde $1\frac{1}{4}$ " Ø (32 mm Ø) en aluminium
- 3 Cornières $1\frac{1}{4}$ " x $1\frac{1}{4}$ " (32 mm x 32 mm) en aluminium
- 4 Poteau S-200 2" x 2" (51 mm x 51 mm) en aluminium
- 5 Poteau tubulaire 1" x 1" (25 mm x 25 mm) en aluminium
- 6 Attache murale
- 7 Insertion diamant

- 1 Aluminium square pickets $\frac{3}{8}$ " x $\frac{3}{8}$ " (9,5 mm x 9,5 mm)
- 2 Aluminium round handrail $1\frac{1}{4}$ " Ø (32 mm Ø)
- 3 Aluminium angles $1\frac{1}{4}$ " x $1\frac{1}{4}$ " (32 mm x 32 mm)
- 4 Aluminium S-200 post 2" x 2" (51 mm x 51 mm)
- 5 Aluminium tubular post 1" x 1" (25 mm x 25 mm)
- 6 Wall mount
- 7 Diamond insert

COULEURS STANDARD STANDARD COLOURS

- Blanc | White
- Noyer | Hickory
- Brun commercial | Commercial Brown
- Gris charbon | Charcoal Grey
- Noir | Black

Ces garde-corps sont entièrement en aluminium soudés et sont recouverts d'une peinture en poudre. | These railings are entirely welded out of aluminium and powder coated.

Nos garde-corps sont faits pour rencontrer les exigences des villes et arrondissements qui ont des règlements de patrimoine semblable au fer forgé d'origine. | Our railings meet the requirements of those cities and boroughs that have heritage by-laws in place requiring railings to have a similar appearance as the original wrought iron.

Consultez les échantillons pour les couleurs exactes et les disponibilités. | Consult our samples for exact colors and availability.





SPÉCIFICATIONS SPECIFICATIONS

Patrimoine Rotondo Heritage Rotondo

Modèle standard

- Garde-corps de 36" (900 mm) et 42" (1070 mm) de haut
- Moins de 4" (100 mm) entre le dessous de la rail du bas et le dessus de la dalle

Regular Design

- Railing 36" (900 mm) and 42" (1070 mm) high
- Maximum of 4" (100 mm) between bottom rail and the slab

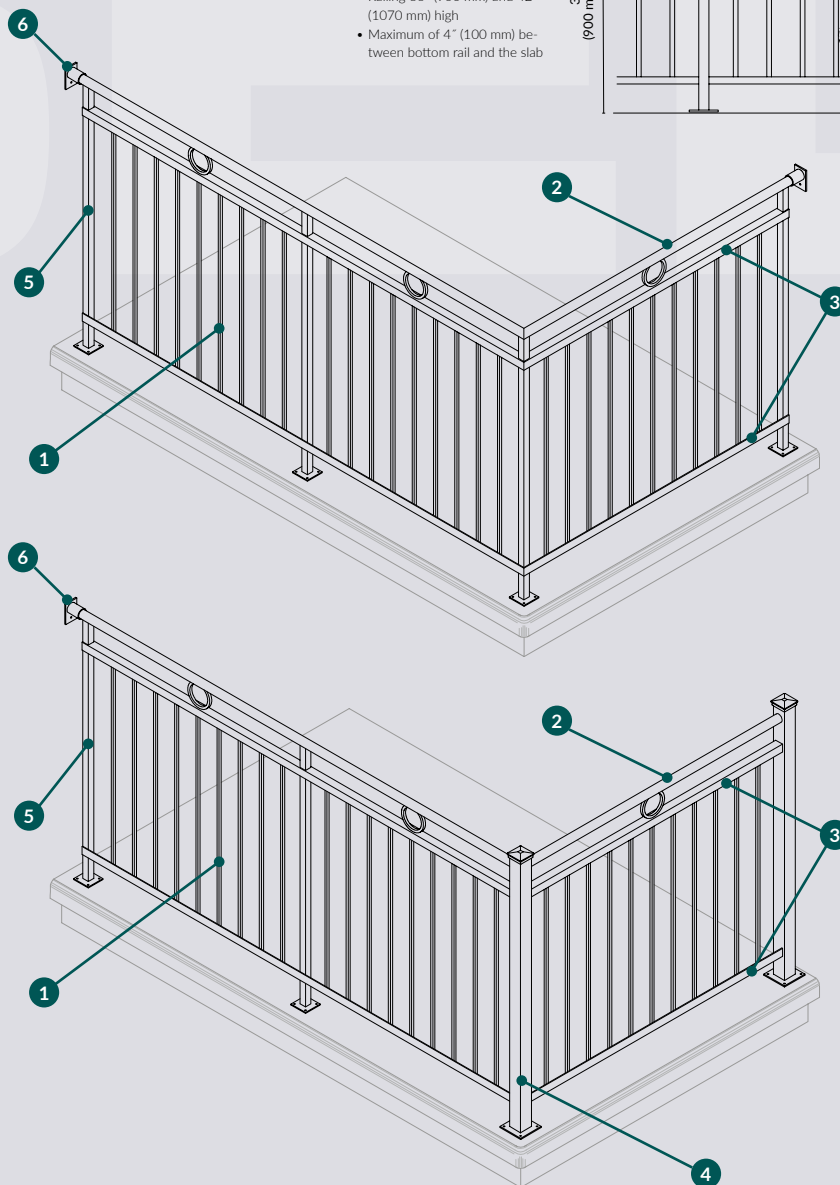
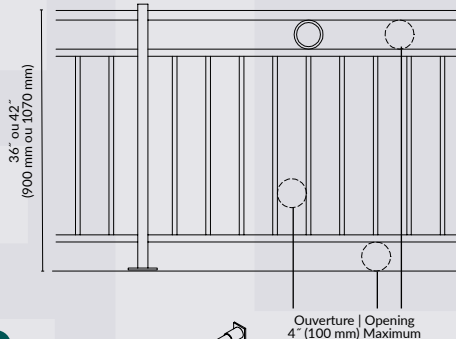

- 1 Barrotins carrés $\frac{3}{8}$ " x $\frac{3}{8}$ " (9,5 mm x 9,5 mm) en aluminium
- 2 Main-courante ronde 1 $\frac{1}{4}$ " Ø (32 mm Ø) en aluminium
- 3 Cornières 1 $\frac{1}{4}$ " x 1 $\frac{1}{4}$ " (32 mm x 32 mm) en aluminium
- 4 Poteau S-200 2" x 2" (51 mm x 51 mm) en aluminium
- 5 Poteau tubulaire 1" x 1" (25 mm x 25 mm) en aluminium
- 6 Attache murale
- 7 Insertion Rotondo

- 1 Aluminium square pickets $\frac{3}{8}$ " x $\frac{3}{8}$ " (9,5 mm x 9,5 mm)
- 2 Aluminium round handrail 1 $\frac{1}{4}$ " Ø (32 mm Ø)
- 3 Aluminium angles 1 $\frac{1}{4}$ " x 1 $\frac{1}{4}$ " (32 mm x 32 mm)
- 4 Aluminium S-200 post 2" x 2" (51 mm x 51 mm)
- 5 Aluminium tubular post 1" x 1" (25 mm x 25 mm)
- 6 Wall mount
- 7 Rotondo insert

COULEURS STANDARD STANDARD COLOURS

- Blanc | White
- Noyer | Hickory
- Brun commercial | Commercial Brown
- Gris charbon | Charcoal Grey
- Noir | Black

Ces garde-corps sont entièrement en aluminium soudés et sont recouverts d'une peinture en poudre. |

These railings are entirely welded out of aluminium and powder coated.

Nos garde-corps sont faits pour rencontrer les exigences des villes et arrondissements qui ont des règlements de patrimoine semblable au fer forgé d'origine. | Our railings meet the requirements of those cities and boroughs that have heritage by-laws in place requiring railings to have a similar appearance as the original wrought iron.

Consultez les échantillons pour les couleurs exactes et les disponibilités. | Consult our samples for exact colors and availability.